

# AEG

Instruction Book  
Gebrauchsanweisung

**QX9 | FLEXIBILITY**

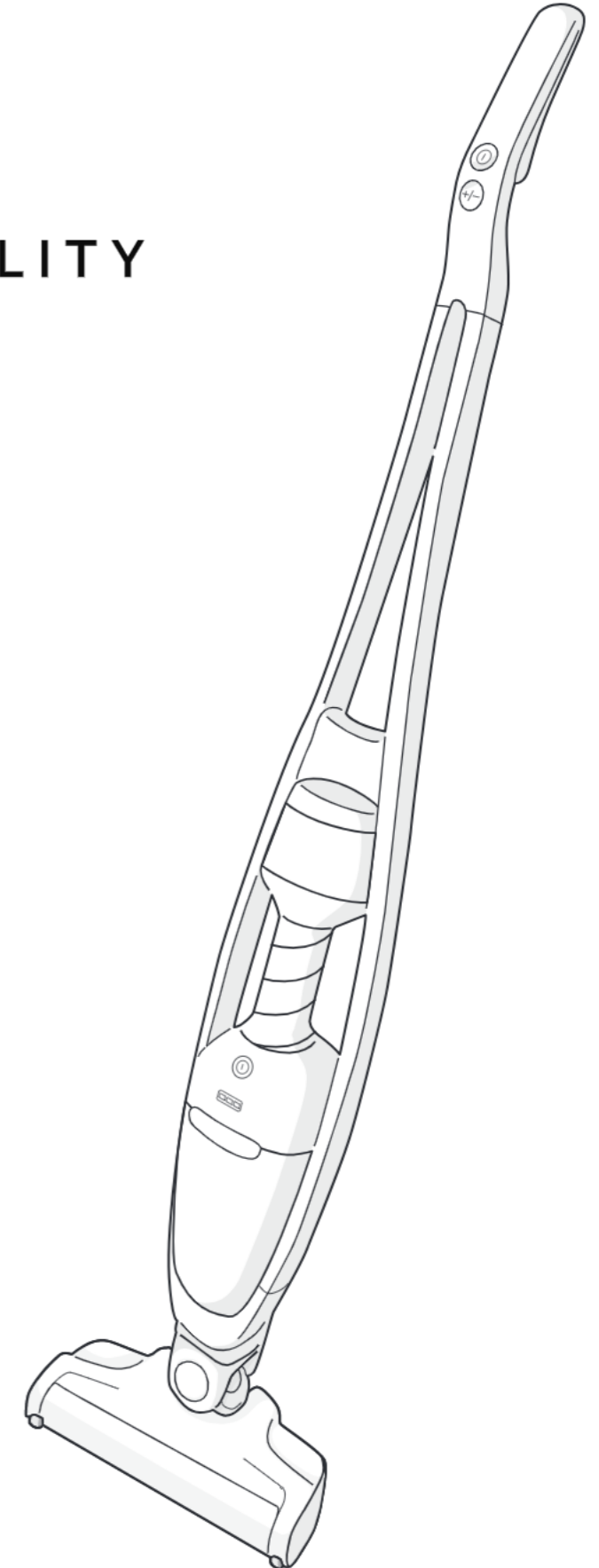

QX9-1-40GG, QX9-1-50IB  
QX9-1-ANIM, QX9-1-ALRG

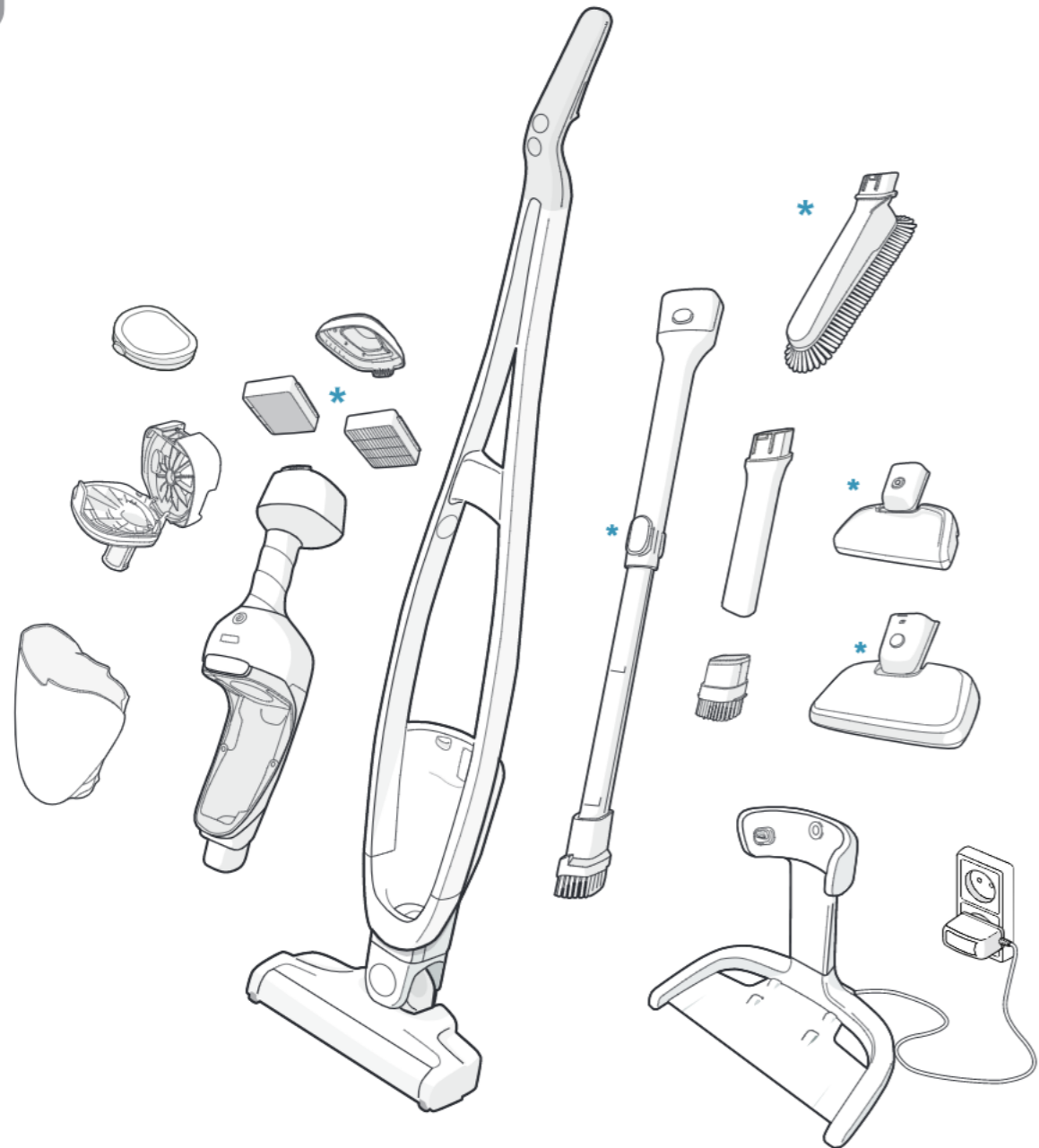

www.aeg.com  
support.emea.aeg.com

\* Accessories may vary from model to model. | Les accessoires peuvent varier d'un modèle à l'autre. | Ausstattung und Zubehör kann je nach Modell variieren. | Accessoires kunnen per model verschillen. | Los accesorios pueden variar según el modelo. | Os acessórios podem variar de modelo para modelo. | Gli accessori possono variare da modello a modello. | Τα εξαρτήματα ίσως διαφέρουν από μοντέλο σε μοντέλο. | رجال الأدوات يمكن ان يختلفون من نموذج الى نموذج.

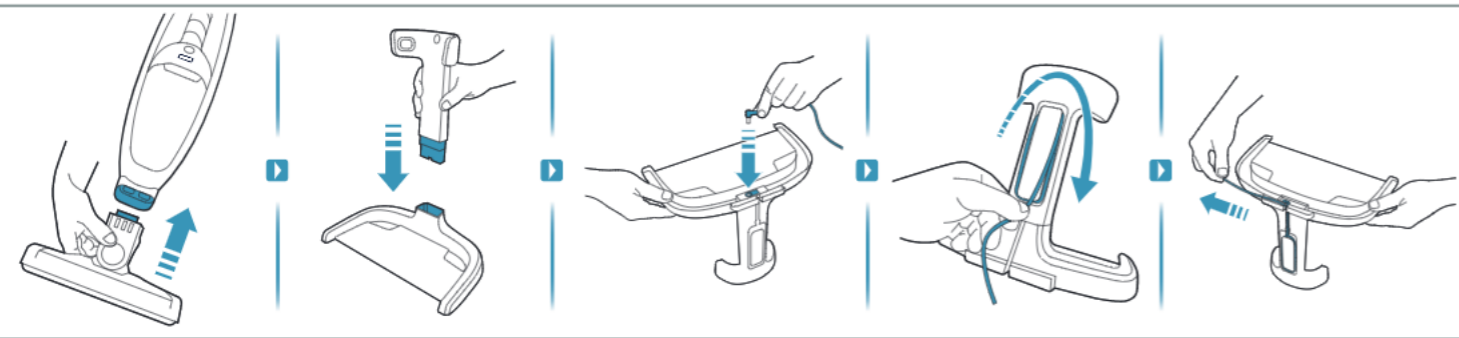

100%
75-100%
50-75%
25-50%
0%

25,2 Volt	15 min	25 min	55 min
21,6 Volt	14 min	23 min	50 min

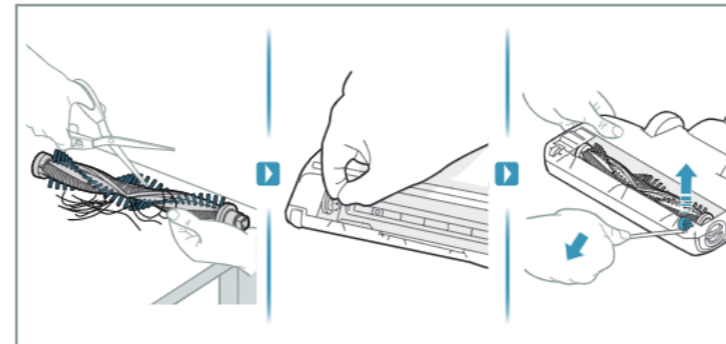
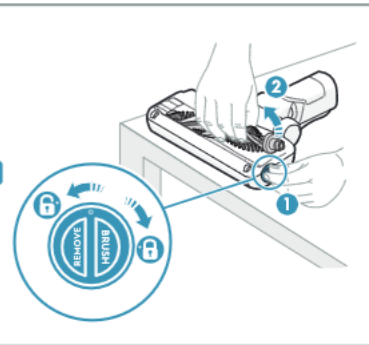
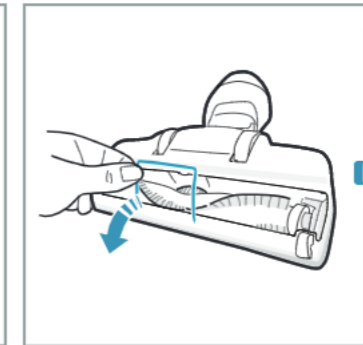
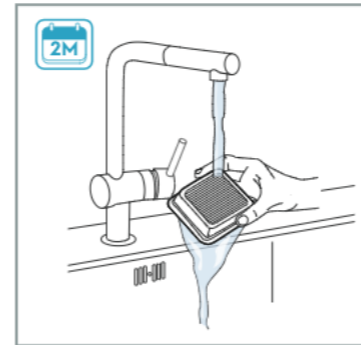
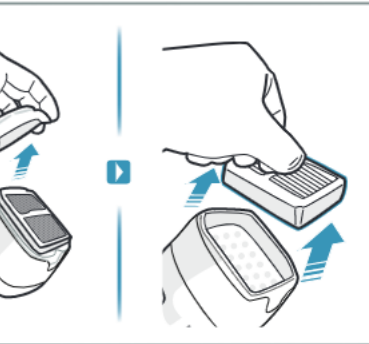
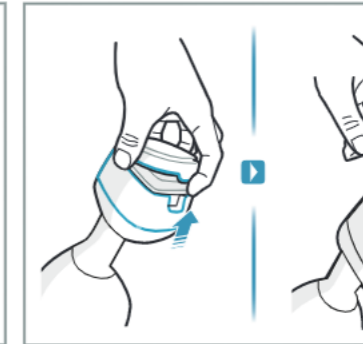
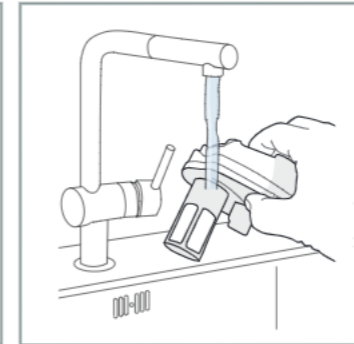
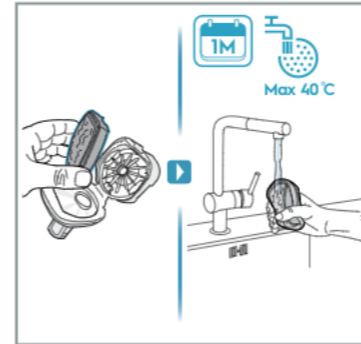
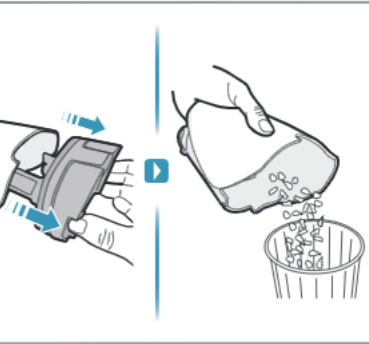
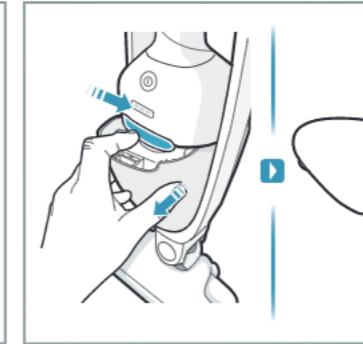
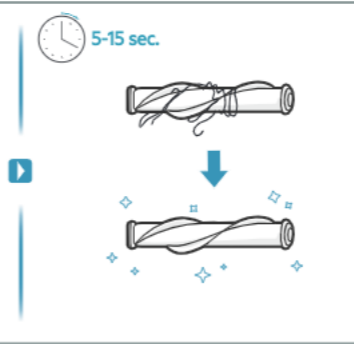
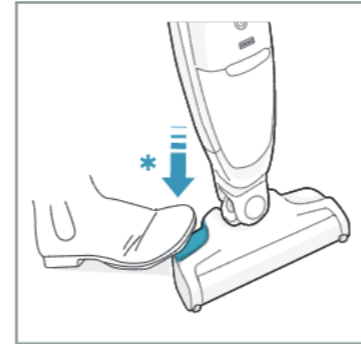
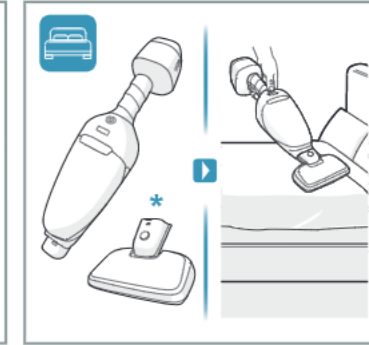
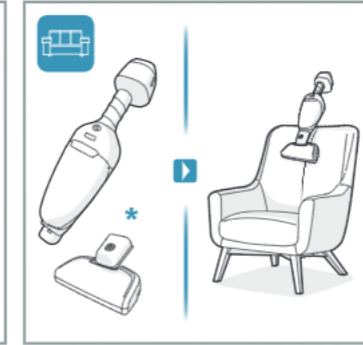
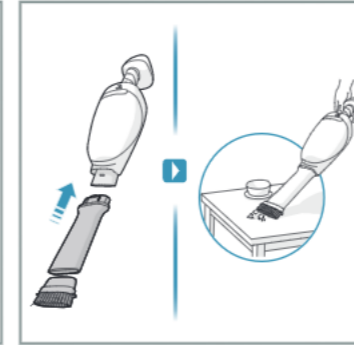
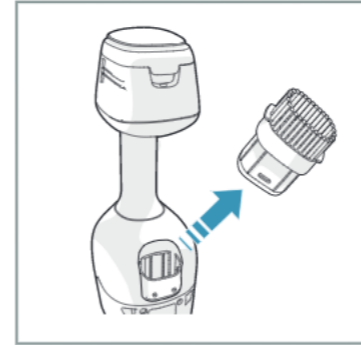

[aeg.com/shop](http://aeg.com/shop)

<b>QX9 performance kit</b> Ref number ; ASQX9 PNC ; 900 923 092	<b>QX9 filter kit</b> Ref number ; AEF167 PNC ; 900 923 093	<b>QX9 360 Home and car kit</b> Ref number ; AKIT19 PNC ; 900 923 094

